

ScanGauge ^{By Linear Logic} **II**™

www.ScanGauge.com



User Manual

Plugs into the diagnostic connector already built into all 1996 or newer cars and light trucks.

Version 6.0

WARNING

Use of the ScanGauge while driving could lead to an accident and serious injuries. The primary attention of the driver should always be on safe driving. As with any gauge or other instrumentation system in a motor vehicle, the information should be observed as part of a normal sequence of observations performed in the operation of the vehicle. Changes to the selections in the ScanGauge should only be made when it is safe to do so. The driver must remain attentive to driving the vehicle.

The mounting of the ScanGauge and the routing of the cable connecting it to the vehicle should be done with suitable caution so it does not create an unsafe condition. This includes but is not limited to the following restrictions:

- **Do Not mount the ScanGauge where it can obstruct the view of the driver.**
- **Do Not mount the ScanGauge in a manner that could cause it to be propelled through the vehicle during an accident causing injury, such as over or near an air bag.**
- **Do Not route the cable in a manner that would interfere with the operation of the vehicle controls.**

RIGHTS AND OBLIGATIONS

The ScanGauge may be used on any number of vehicles. The software contained in the ScanGauge is copyright protected by Linear Logic and may not be transferred or disassembled and used in another product, in part or in whole. The artwork used in generation of the circuitry is also copyright protected and cannot be used in part or in whole by any person or entity without the express written permission of Linear Logic.

© 2004-2011 by Linear Logic. All rights reserved.

Installing the ScanGauge	4
ScanGauge Overview	5
Basic Operation and Features	6
Installation	8
Setup and Calibration	10
Basic Setup Options	11
Advanced Setup Options	14
Backlight Display	18
Calibration	20
Operating Your ScanGauge	22
Digital Gauges	23
Trip Computers	26
Scan Tool	33
Advanced Features	37
X-GAUGE™	38
Performance Monitor™	44
Custom Commands	50
Troubleshooting	52
Where to Get Support	53
View Firmware Version of Your ScanGauge	55
Reset Your ScanGauge	56
Read or Set the Operating Mode	57
Warranty Information:	60

Version 6.0

Information in this manual and the specifications and operation of the ScanGauge itself are subject to change without notice.

Installing the ScanGauge

The ScanGauge is simple to install and requires no additional power source other than the OBD II connector.

There are, however, some important considerations when choosing a location for your ScanGauge. Please see the Installation section for detailed information.

ScanGauge Overview	5
Basic Operation and Features	6
Locating the OBDII Connector	8
Mounting Your ScanGauge	8
Connecting Your ScanGauge	8
Important Installation Considerations	9

ScanGauge Overview

Package Contents

- ScanGauge
- Velcro® Strips
- Quick Start Guide
- 6ft OBDII Cable
- User Manual

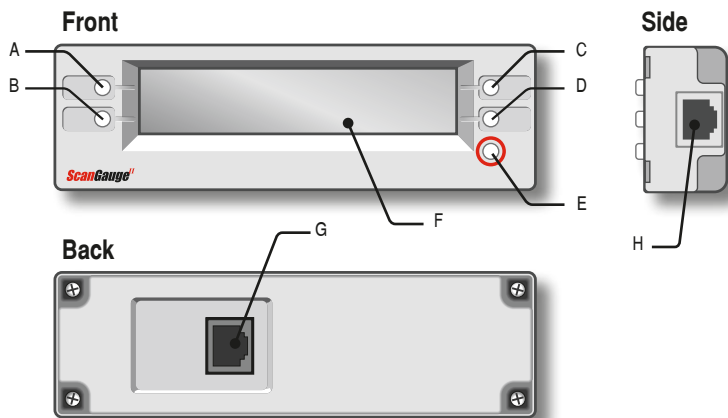

A.	Function/Selection Button	The function buttons are used to make selections and to navigate the menu system of the ScanGauge.
B.	Function/Selection Button	
C.	Function/Selection Button	
D.	Function/Selection Button	
E.	HOME Button	Use the HOME Button to quickly get back to the Home Screen
F.	LCD Display Screen	Displays the information the ScanGauge records
G.	OBDII Connection Plug	Primary OBDII connector
H.	Optional OBDII Connection Plug	Secondary OBDII connector

Basic Operation and Features

Menu and Selection Buttons

The ScanGauge interface is made up of 5 buttons; one HOME and 4 function/select buttons. The HOME button, located in the lower right corner of the front face and marked with a red circle, has a single function — to display the Home Screen. Pushing the HOME button will always display the Home Screen as shown to the right.



Push the HOME button to return to the HOME menu at anytime.

Example Screens

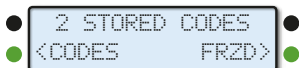
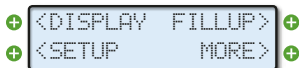
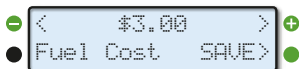

The function/select buttons are located at each corner of the display. The function of these buttons will vary depending on the particular screen you are currently viewing.

In general, when a "<" or ">" is displayed next to the button, pressing the button will move you to the next or previous selection for the currently selected feature .

To the left are a few examples of screens you may encounter while using your ScanGauge. Use the diagram for an explanation of possible button functions.

Automatic Mode Recognition

Different vehicles use different types of signaling from their computers. In most cases, the ScanGauge can quickly determine which type your vehicle is using. You don't have to know which type it is for it to be used.

Automatic Repeat Buttons

Pressing the buttons and holding them for more than a second will cause them to automatically repeat at a rate of about 2 times a second. This allows for rapid stepping to a value without a lot of button pressing.

User Programmable Gauges

Up to 25 trip, vehicle specific or special gauges can be entered into the ScanGauge. These are stored in Flash memory and will be retained even if there is a power loss, but the user can change them as often as desired.

Button Symbols

Symbol	Function/Action
>	Move to next selection or do action
<	Move to previous selection or do action
^	Increment up
+	Increment up or step forward
-	Increment down or step backward

User Programmable Commands

Up to 10 commands can be generated, edited, saved and sent to the vehicle computer. This allows for future codes and some special commands to be added by the user.

Flash Memory

The ScanGauge uses a type of memory that doesn't require batteries or a source of power to maintain. This means that your settings will not be lost if you disconnect the vehicle battery or disconnect the ScanGauge.

Automatic Sleep Mode

About 12 seconds after turning off the vehicle or pressing a button after the vehicle engine is turned off, the ScanGauge will automatically power down into a sleep mode. Starting the engine or pressing the HOME button will automatically reactivate the ScanGauge, and it will return to the screen and lamp settings it had just before it went to sleep.



If you need to disconnect the ScanGauge, wait until it has gone to sleep before you do it. This will allow all settings and trip information to be saved in Flash memory and restored when it is reconnected.

Customizable Backlight Color

Choose from 7 standard backlight colors or program your own for 63 possible colors. The backlight intensity is also adjustable and can be set to Off, Low and High intensities.



SCAN

Use the Scan Tool to view and clear Trouble Codes and turn off the check engine light

TRIP

Press the function button next to TRIP to access the 4 built-in Trip computers. The built-in Trip computers give you the ability to view and track useful information about the trip you take as you drive.

GAUGE

Use the function button next to GAUGE to display up to 4 real-time Digital Gauges

MORE

Press the function button next to MORE to access the settings and configuration options for the ScanGauge.

Installation

1. Locate the OBDII connector.

This connector is normally located under the dash on either side of the steering column. It can also be located under the dash on the passenger side in some vehicles. On rare occasions it is behind the ashtray in the dash or in the armrest. It may have a cover on it that can be pulled off by hand.

2. Locate a place for the ScanGauge.

You can use the sticky-back Velcro[®] supplied with the ScanGauge to attach it to the location you have chosen. The Velcro[®] attachment allows you to easily remove it and use it to troubleshoot another vehicle and then return it to this vehicle.

The location should be where it can easily be seen from the normal driving position. It should not be placed where it will obstruct the driver's view outside the vehicle or of other gauges.



DO NOT mount the ScanGauge over an air bag cover where it could be propelled by a deploying air bag.

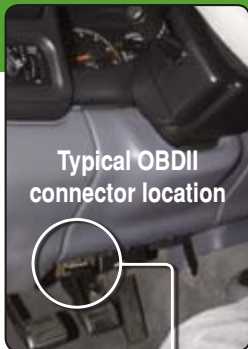

Typical OBDII connector location

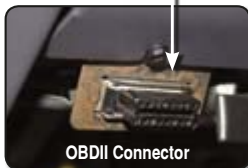

OBDII Connector

3. Route the cable.

Route the cable from the OBDII connector and plug the small end of the cable into the back or side of the ScanGauge.



IMPORTANT: A pin in the cable is connected to the vehicle's 12V system. Do not short any pins of the small connector to metal or other ground when the OBDII plug is plugged into the OBDII connector.



Large end of the cable connects to your vehicle.

4. Turn the vehicle on.

If the vehicle can be run, start it. If it cannot be run, turn the key to the Run position. This is the position it is normally in when the vehicle is being driven.

5. Plug the ScanGauge plug into the OBDII socket.

The ScanGauge derives all the power it needs from the OBDII connector. No other connections are needed for its operation.

Wait for the ScanGauge to connect. When the ScanGauge is first connected, it attempts to



Small end of the cable connects to your ScanGauge.

communicate with the vehicle. Communications can be established with the key in the Run position, even if the engine is not actually running. It could take up to 60 seconds for the connection to be made after the unit is plugged in with the key in the Run position.

While establishing communications, the screen will display:

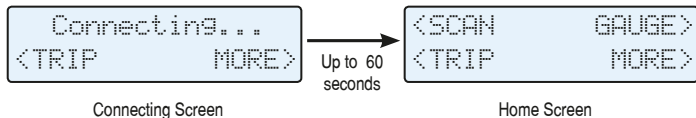

If it does not stop saying “Connecting...” or the screen goes blank after 60 seconds, refer to [Troubleshooting on page 52](#).

The TRIP and MORE buttons can be used even if a connection is not established. If communication with the vehicle ECU is not completed within about 75 seconds, the ScanGauge goes to sleep. It will continue to attempt to connect when the vehicle is restarted or the HOME button pressed. When communication has been established, the display will change over to that which was displayed the last time it went to sleep or to the Home Screen.

6. If this is the first time it has been used on this vehicle, follow the procedures outlined in [Setting Up Your ScanGauge, on page 11](#).

Important Installation Considerations

The ScanGauge has an operating temperature range of 0°F to 160°F (-18°C to 71°C). At higher temperatures, the display will become dark and difficult to read. At lower temperatures, the contrast will be reduced and the characters will change more slowly. As long as the temperature doesn't exceed -22°F to 176°F (-30°C to 80°C), the display will return to normal operation when the ScanGauge temperature returns to the normal operating temperature range.

- A location in direct sunlight on the dashboard in a closed vehicle could exceed the normal operating temperature. The use of windshield shades or covering the ScanGauge with a piece of paper can significantly reduce this temperature. If attached with Velcro®, you can also move it temporarily to a location away from the sun.
- DO NOT mount the ScanGauge over an air bag cover where it could be propelled by a deploying air bag.
- A pin (pin 16) in the cable is connected to the vehicle 12V system. DO NOT short any pins of the small connector to metal or other ground when the OBDII plug is plugged into the OBDII connector.
- The location should be where it can easily be seen from the normal driving position. It should not be placed where it will obstruct the driver's view outside the vehicle or of other gauges.

Set Up and Calibrate Your ScanGauge

To get the most out of your ScanGauge, it is important to follow the setup and calibration procedures to ensure your ScanGauge reports accurate information.

This section outlines the various setup options and provides detail information about calibrating the ScanGauge for the most accurate readings.

Setting Up Your ScanGauge

Initial Setup Overview	11
Advanced Setup Overview	14
Backlight Display Options	18

Calibration

Calibration Overview	20
First Fill-up Procedure	20
Helpful Calibration Tips	21
Second Fill-up Procedure	21

Setting Up Your ScanGauge

Initial Setup Overview

To properly use your ScanGauge, you must first set up the vehicle parameters. Basic setup parameters include engine size, fuel tank size, fuel type and unit of measure. Advanced parameters are also available and are covered later in this chapter.

Access the Setup Options

To access the setup screens, press the function button next to MORE on the Home Screen. Next press the function button next to SETUP.

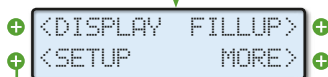

Displays the currently selected setup parameter

Use the upper buttons to move to the next or previous setup parameter

Use the lower buttons to adjust the currently selected setup parameter

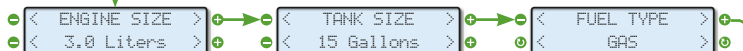
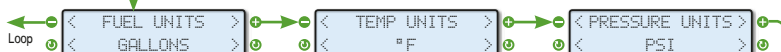

See page 14 for Advanced Setup Options

Basic Setup Parameters

Setup Parameter	Display	Options	Description
Distance Units	DISTANCE	Miles Kilometers	The Setup Parameters include multiple units of measure settings, including Distance, Fuel, Temperature and Pressure. Each is set independently of the other and can be used in any combination.
Fuel Units	FUEL UNITS	Gallons Liters	
Temperature Units	TEMP UNITS	Fahrenheit (°F) Celsius (°C)	Making changes to these settings causes your ScanGauge to use these units when reporting and measuring data.
Pressure Units	PRESSURE UNITS	PSI KPA	
Engine Size	ENGINE SIZE	0.0 - 9.9 (Liters)	Increase or decrease the Liters size until it matches the size of your engine.
Tank Size	TANK SIZE	0 - 255 Gallons/liters	Is adjustable in 1-gallon or liter increments depending on how you set the FUEL UNITS parameter.
Fuel Type	FUEL TYPE	GAS DIESEL ^a DIESEL ^b HYBRID LPG.	Most diesel vehicles use the DIESEL ^a setting. See special notes below. Hybrid vehicles must choose HYBRID or the ScanGauge will go to sleep when the engine automatically shuts off. Set to LPG for propane powered vehicles.
Currency Type	CURRENCY	\$, £, ¥, €	Choose the currency symbol ScanGauge should use to display monitor values.

Tips for Setting the Tank Size

The size will use Gallons or Liters depending on the selection you made in the Fuel Units Screen (FUEL UNITS). If the size in the manual is not in whole units, use the next lower value. For instance, if the capacity is 17.5 gallons, use 17 gallons.



It is dangerous to run a vehicle out of fuel and can damage the fuel pump. Do not rely on the fuel gauge or ScanGauge at low fuel levels or low remaining distance or time.

Can the ScanGauge use Imperial Gallons?

ScanGauge uses gallons as a unit label, not a unit of measurement. Because of this, it can read in either US or Imperial Gallons without conversion. Make sure all units entered into ScanGauge are consistent, and the readings should remain accurate for US or Imperial Gallons.

Can ScanGauge Display Liters per Hundred Kilometers?

By default, ScanGauge will express fuel economy in Liters per Hundred Kilometers (LHK), provided you have set fuel to LITERS and distance to KILOMETERS. For more information see LHK under Advanced Setup on page 14.

Diesel Vehicles: Determining the Diesel Type

If your vehicle uses diesel fuel and you're not sure which setting to use in the FUEL TYPE parameter, you can determine the type by performing the following procedure:

- Set the ENGINE SIZE to match the liter size of your vehicle's engine
- Set FUEL TYPE to DIESELa.
- Run the engine until warmed up to operating temperature.
- Park the vehicle and set it in Park or Neutral.
- While the engine is idling, select GAUGE from the Home Screen, and set one of the gauges to show RPM and another to show GPH. You can set the gauges by pressing the function buttons next to the gauge position you wish to change.
- Make note of the GPH value.
- Next, use the throttle to raise the engine RPM to about 1500 RPM. If the GPH reading increased, you have a DIESELa vehicle. If the GPH dropped or stayed the same, you have a DIESELb vehicle and should change the FUEL TYPE to DIESELb.

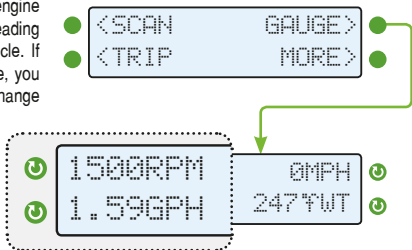

Advanced Setup Options

Advanced Setup Overview

The Advanced Setup Options provide additional setup parameters you can use to adjust the functions and features of the ScanGauge to suit both your vehicle and your preferences.

ScanGauge provides a number of advanced setup parameters, including the ability to adjust the reported speed to compensate for oversized tires and the ability to set the fuel cutoff level, as well as the update rate at which ScanGauge reports data.

This section provides a brief overview of each of the advanced parameters but may not cover the full scope of the subject the setting applies to.

For more information, visit: www.ScanGauge.com/support.

Accessing the Advanced Setup Options

The Advanced Setup Options are located within the SETUP menu. To access the Advanced Setup Options screens, press the lower right function button next to MORE on the Home Screen. Next press the lower left function button next to SETUP.

Once on the Setup Screen, use the upper left or right function buttons to cycle through the available screens until the screen displays ADV SETTINGS. Press the lower right function button next to EDIT to enter the Advanced Setup Options.

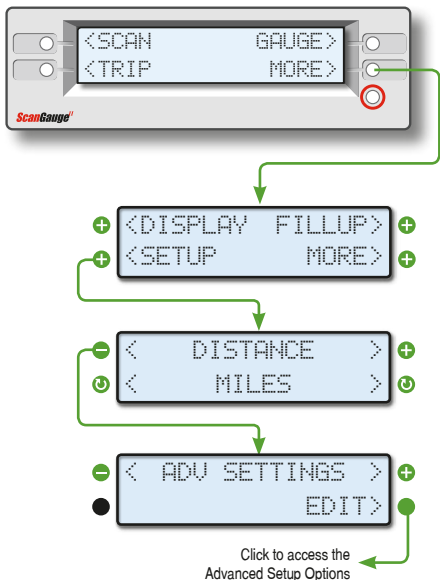

Advanced Setup Parameters

Setup Parameter	Display	Options	Description
Data Update Rate	UPDATE RATE	Slow Normal Fast	Sets the rate in which ScanGauge reports data. See below.
Speed Adjustment	SPEED	-100%-100%	Sets the speed offset to compensate for inaccurate speed readings. See page 15 and 16.
Fuel Cutoff Setting	CUTOFF	0-99 (Default: 24)	Sets the fuel cutoff level. See page 16.
Parameter Identification Descriptor method	PIDS	ALL Supported	Sets the PID method. See page 16.
Liters per Hundred Kilometers	LHK	OFF ON (Default)	Displays fuel economy in Liters per Hundred Kilometers. See page 17.
Diagnostic Trouble Codes Clear Method	DTC	Normal ALT	See page 17.
Sleep Event	SLEEP EVENT	0 RPM (Default) NO COMM	Sets the ScanGauge power down event. See page 17.
Manifold Pressure Method	MAP OR BOOST	MAP (Default) BST	Allows you to set how Manifold Pressure is calculated. See page 17.
Horsepower Adjustment	HP	-99% - +99% (Default 0)	Sets the HP offset to compensate for in-accurate Horsepower readings. See page 17.

UPDATE RATE

You can adjust the rate in which ScanGauge reports data. The effect of this setting is most visible in the Gauge Screen.

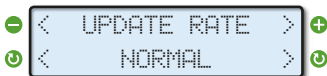

The update rate defaults to NORMAL. In some cases, a faster update rate can be used. If this causes some updates to be skipped or irregularly operate, FAST should not be used. In some cases, even NORMAL can be too fast and lead to poor operation.

In these cases, SLOW should be used. PWM and all the CANxx modes can usually use FAST rate. VPW, ISO and KWP modes may have a problem with a rate higher than NORMAL.

Set Speed Adjustments

The speed indicated by ScanGauge can be adjusted to compensate for changes in tire size, gear changes, tire



wear or any other factor that may affect the accuracy of your vehicle's speedometer. It is important to note that this adjustment only affects the ScanGauge's indicated speed and distances, and it does not affect the vehicle speedometer or odometer readings.

While viewing the SPEED Screen, the lower left and right function buttons can be used to increase or decrease the selected adjustment in 1% steps.

The upper line displays the word SPEED and a percentage. The percentage is the adjustment factor. The lower line displays 2 numbers: the left number is the speed reported by the vehicle and the number on the right is the speed that will be shown by the ScanGauge after applying the correction factor.

One accurate way to set the speed is to use a GPS. With one person driving, the other person observes the speed on the GPS and adjusts the percentage until the lower right number agrees with the speed the GPS indicates.

For more information about the various methods of calculating your speed adjustment, visit us online at www.ScanGauge.com/quick-tips/.



IMPORTANT: OBSERVE ALL SPEED LIMITS AND DRIVE SAFELY WHILE MAKING THESE ADJUSTMENTS. THE DRIVER MUST NOT BE DISTRACTED BY TRYING TO MAKE THESE ADJUSTMENTS WHILE DRIVING.

Set the Fuel Cutoff Level

Some vehicles will turn the fuel injectors off while coasting – this is known as Fuel Cutoff. ScanGauge attempts to detect the fuel cutoff condition by comparing the open/closed loop indicator and the throttle position. If ScanGauge improperly detects fuel cutoff, then you may see fuel economy being reported as 9999 MPG or 0.00 LHK.



The CUTOFF parameter allows you to set the point at which ScanGauge can determine the throttle is closed and in the fuel cutoff condition. The default value of 24 is usually correct for most vehicles but may need to be adjusted. This setting is not critical but is best at about 4 above the no-throttle TPS value. You can choose to disable the fuel cutoff sensing feature of the ScanGauge by setting the value of CUTOFF to 0.

Set PID Method

Use the PIDS menus to set the method ScanGauge uses to store Parameter Identifications Descriptors (PIDs) codes.



Most vehicles use ALL, which is the factory default. But some vehicles will not work properly unless SUPPORTED is used. This is the case for 1995 to 1999 Subaru vehicles. If the ScanGauge connects but then goes to sleep after showing little or no data on the GAUGE display, change this to SUPPORTED.

LHK

Liters per Hundred Kilometers (LHK) is a popular way to express fuel economy in Europe.

By default, ScanGauge will express fuel economy in LHK, provided you have set fuel to LITERS and distance to KILOMETERS as outlined in the Basic Setup procedure (see page 12).

If you would prefer fuel economy to be expressed as Kilometer Per Liter (KPL), set the LHK parameter to OFF. With LHK set to OFF, and fuel and distance set to LITERS and KILOMETERS, the ScanGauge will now express fuel economy in Kilometers Per Liter (KPL).



IMPORTANT: Lower LHK values represent a higher fuel economy, unlike KPL where a higher number represents higher fuel economy.

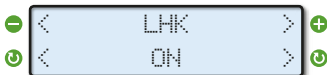

DTC

Some vehicles may not respond properly when attempting to retrieve or clear Diagnostic Trouble Codes (DTC). By default, this parameter is set to NORMAL. If you experience trouble, set this parameter to ALT.



Set the Sleep Event

By default, the ScanGauge will shut down when it sees 0 RPM. This may not be the desired setting if your vehicle is a Hybrid, which will report 0 RPM when the vehicle is stopped. When you select HYBRID in the fuel type (TYPE) parameter in the Basic Setup procedure (see page 11), ScanGauge will automatically set the Sleep Event parameter to NO COM.



When using ScanGauge with the Sleep Event parameter set to NO COM, there is a small risk that the vehicle's ECU and ScanGauge will stay on and drain the battery. You must be sure the ScanGauge goes to sleep properly when the engine is turned off.

Set a Horsepower Adjustment

ScanGauge reports Horsepower (HP) as a built-in digital gauge. This parameter allows you to make adjustments to the HP reading ScanGauge reports.

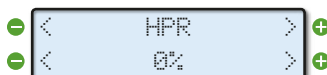

Set the Manifold Pressure Method

If your vehicle is equipped with a turbocharger or supercharger, you may want your vehicle's manifold pressure calculated and reported as Boost (BST)

as opposed to Manifold Absolute Pressure (MAP). This parameter allows you choose the method ScanGauge should use to calculate and display manifold pressure.



Backlight Display

Backlight Display Options

You can customize the backlight display of your ScanGauge. Options include the ability to set the intensity of the backlight, choose a standard built-in color for the backlight, and create your own custom color.

Access the Display Options

To access the Display Options Screen, press the function button next to MORE on the Home Screen. Next, press the function button next to DISPLAY.

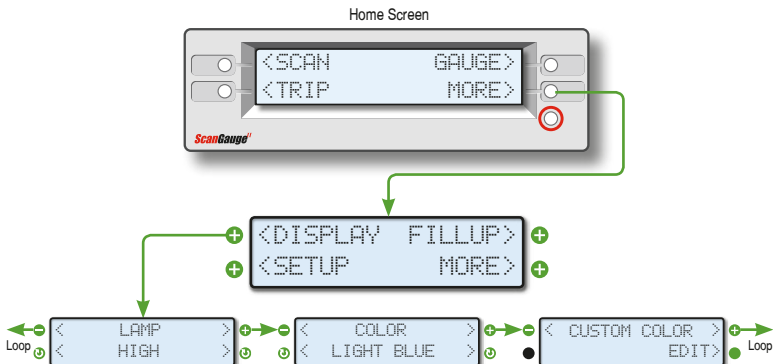

Change the Backlight Intensity

Use the lower left and right function buttons to adjust the backlight intensity. Options include:

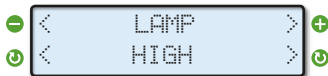

Backlight Color Options	
Sequence	Setting
1	HIGH (Default)
2	LOW
3	OFF

Change the Backlight Color

Use the lower left and right function buttons to cycle through the available colors.

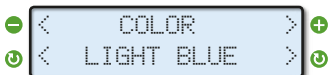

Use lower function buttons to choose a backlight color

Backlight Color Options

Sequence	Color
1	Light Blue
2	User Defined (Custom Color)
3	Blue
4	Green
5	Blue-green
6	Red
7	Violet
8	Amber

Set a Custom Backlight Color

The backlight can be customized by setting the intensity of the three basic colors — Red, Green and Blue — for a total of more than 60 possible colors. The example to the right is what you would see for a Pink backlight.

To create your own color, start by pressing the function button next to a color. This will cause it to sequence through 4 possible values ranging from off — a setting of 0, to full intensity — a setting of 3. As you press the buttons, the backlight will change to show the color result of the current selections.

If you have previously set the intensity at LOW, the display will show the color at the low intensity level. If you had set it at HIGH, the display will show the color at the high intensity level. Note: there may be a small difference in color between LOW and HIGH.

When you have the color you want, press the function button next to SAVE. This will save the color in Flash memory. You can change the color as often as you want.



Custom Color Adjustments

Value	Color Intensity
0	0 intensity (Off)
1	1/4 intensity
2	1/2 intensity
3	Full intensity

Calibrating Your ScanGauge

Improving the Accuracy of Your ScanGauge

The accuracy of your ScanGauge can be improved by calibrating the fuel consumption. Calibrating your ScanGauge to accurately report fuel consumption is a 2-step process: your **first fill-up** and your **second fill-up**.

While both steps involve using the FILLUP function of your ScanGauge, the procedures for Step 1 and Step 2, vary slightly from each other. Please read carefully.

Access the FILLUP Menu

To access the FILLUP screen, press the function button next to MORE on the Home Screen. The next screen will be the FILLUP screen. Press the upper right function button to enter the Fill-up function.

Before proceeding, read through the tips below for some helpful information and the procedure for your first fill-up.

Step 1 - Your First Fill-up

Follow these calibration instructions only when you are filling your fuel tank. If you do not fill your tank to its capacity, then the calibration process will not produce accurate results.

- 1) Fill up the tank, letting the pump shut off automatically.
- 2) Use the FILLUP function to tell ScanGauge you have filled the tank. From the Home Screen, follow the sequence shown to the right.

3) **On your first fill-up, DO NOT make any adjustments to the indicated fuel. Simply press the lower right button to move to the next screen.**

- 4) Next, the Fuel Cost Screen will appear. Use the upper left and right function buttons to adjust the cost per gallon/liter, and press the lower right function button next to SAVE.
- 5) Keep the ScanGauge connected to your vehicle and use the vehicle normally.
- 6) Once you reach approximately 1/4 tank of fuel left, follow the directions in Step 2.

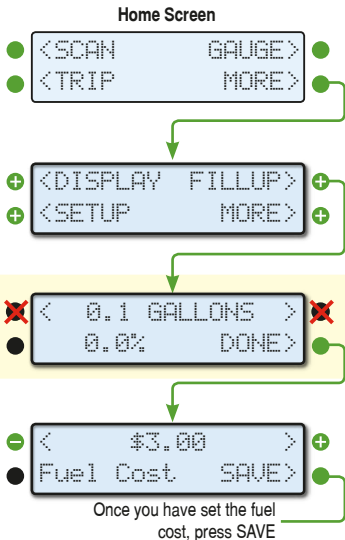

Helpful Calibration Tips:

- When filling the tank on your second fill-up, try to use the same pump you used for your first fill-up with the vehicle pointed in the same direction. If you fill up your fuel tank with your vehicle on an incline, it can have an effect on the amount of fuel the pump can dispense into your tank.
- When filling your tank, let the pump shut off automatically. Do not top off.
- To maintain accurate "TO EMPTY" information in the ScanGauge's trip computers, you should always fill your tank to capacity and follow the FILLUP sequence in Step 2.
- Once you have completed your second fill-up, subsequent fill-ups may not require adjusting the gallons/liters before pressing DONE.

After following the initial calibration procedure, you should follow Step 2 for each subsequent fill-up.

If you miss a fill-up procedure after filling your tank, start with Step 1 of the calibration process on your next fill-up to maintain accuracy.

Step 2 - Your Second Fill-up and Subsequent Fill-ups

Home Screen



1) When the tank is around 1/4 full, fill up your tank again. Be sure to let the pump shut off automatically

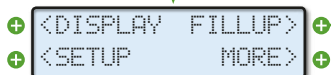

2) Use the FILLUP function to tell ScanGauge you have filled the tank. From the Home Screen, follow the sequence shown to the left.



3) The next screen will show the amount of fuel your ScanGauge believes was used since the previous fill-up. **Use the upper left and right function buttons (A,C) to adjust the amount of fuel you actually put in the tank.**

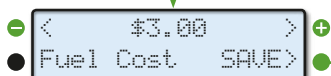

4) Push the lower right function button to save the value and complete the fill-up process.

Once you have set the fuel cost, press SAVE.

5) Next, the Fuel Cost screen will appear. Enter the cost per gallon/liter and press the SAVE button.

Operating Your ScanGauge

The ScanGauge features a simple and easy-to-use, menu-driven design. After each button is pressed, new selections will appear in the display prompting you for what can be done next.

The HOME button (button with a red circle around it) will take you back to the starting point at any time, or activate the ScanGauge if asleep.

Digital Gauges

Digital Gauges Overview	23
Digital Gauge Abbreviations	24

Trip Computers

Trip Computer Overview	26
Time-based Trip Computers	28
Resetting Current Trip Data	29
Fuel-based Trip Computers	29
Filling Up Your Tank	31

Scan Tool

Scan Tool Overview	33
What to Do if DTCs Are Found	34
Pending Trouble Codes	35
Clearing Trouble Codes	36

Digital Gauges

Digital Gauges Overview

The ScanGauge can display up to 4 digital gauges at a time. The gauges are updated in real time when your vehicle is running and can be used to monitor the operating condition of your vehicle.

Access the Digital Gauges

From the Home Screen, pressing the button next to GAUGE causes the display to change to show the currently selected gauges.

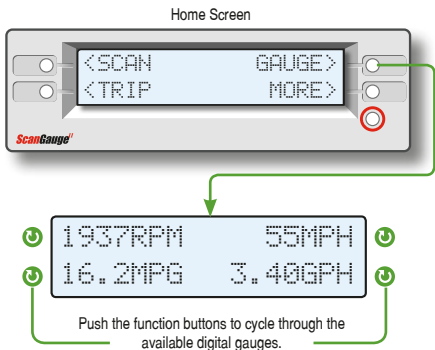

Selecting the Gauges

Pressing the button next to one of the gauges will allow you to change the gauge that is displayed in that position. Pressing a button repeatedly, allows you to cycle through all the available gauges.

The selection will continue through all of the gauges and then loop back to the starting gauge. This gives you the ability to customize the gauge display to show the gauges you're most interested in.



The information available will vary from vehicle to vehicle. If the information is not available for a certain gauge, no data will be shown for it. If the same gauge is selected for more than one position, only one of them will show data (if it is available). The other positions will show the abbreviation, but no data.

Gauge Abbreviations

The following table shows what the gauge names. In some cases, the unit selections made in the **Basic Setup Parameters** (see page 12) will determine the gauge abbreviations.

The information available will vary from vehicle to vehicle. If the information is not available for a certain gauge, no data will be shown for it. If the same gauge is selected for more than one position, only one of them will show data (if it is available). The other positions will show the abbreviation, but no data.

Gauge	Name	Description
CLSD LP OPEN LP	Fuel System Loop Status	This indicates when the oxygen sensor is being used to control the mixture (closed-loop) and when it is not (open-loop). It is usually closed except when the engine is cold or under full throttle acceleration.
MAP BST	Manifold Absolute Pressure Boost	This indicates the pressure in the intake manifold. It is reported in Pounds per Square Inch (PSI) by default but can be changed to kilo-pascals (KPA) if desired. If the engine is turbocharged or supercharged, you can set ScanGauge to calculate and display this gauge as Boost (BST) through the Advanced Setup parameters (see page 15)
MPG KPG MPL LHK KPL	Miles Per Gallon Kilometers Per Gallon Miles Per Liter Liters Per 100Km Kilometers Per Liter	Instant fuel economy is updated about every 2 seconds at the NORMAL update rate . Small changes in throttle position or load while driving will show almost immediate changes in this gauge.
MPH KPH	Miles Per Hour Kilometers Per Hour	Speed in the units selected
RPM	Revolutions Per Minute	The RPM of the engine
TPS	Throttle Position Sensor	In some vehicles, a closed throttle will read 0 and full throttle will read 100. Other vehicles will have a higher value than 0 for a closed throttle and a full throttle value less than 100.
FWT CWT	Water Temperature	Water/Coolant temperature A vehicle with a 50/50 mix of coolant and water will not boil over until about 265° F at sea level. This will be reduced at higher elevations.
AVG	Average Fuel Economy	This is the current average fuel economy and is updated about every 2 seconds (normal rate).
TFC	Trip Fuel Cost	This is the total fuel cost for the current trip.
CPM	Cost Per Mile	Cost of fuel per mile at this time

Add Custom Gauges

The ScanGauge features the exclusive X-GAUGE™ programmable gauge system allowing you to add custom, vehicle specific gauges to the digital gauge set.



For an overview of the X-GAUGE™ system, see page 37. For an up-to-date list of known X-GAUGE™ codes, visit us online at: www.ScanGauge.com/support

Gauge	Name	Description
VLT	Battery Voltage	Normal running battery voltage is between 13 and 15. When the engine is off it should be between 11 and 13. Voltages higher than 15 volts can damage batteries and electrical components. Voltages below 13 when the vehicle is running could indicate poor charging of the battery. Voltage below 11 when the engine is off could indicate a low battery charge or a shorted battery cell.
FIA CIA	Intake Air Temperature	Temperature of the air going into the engine. At highway speeds, this will typically be a few degrees higher than the outside air temperature. At idle or low speed, it may be much higher in temperature than the outside temperature due to the low airflow into the engine and the high under-hood temperatures warming it up.
FPR	Fuel Pressure	This is the fuel pressure from the fuel pump. Very few vehicles report this.
GPH LPH	Gallons Per Hour Liters Per Hour	Fuel consumption rate in the selected units. This is sensitive to throttle, gear and loading changes.
IGN	Ignition Timing	Shows the amount of timing advance (or retard). The more advance there is (or less retard), the better for fuel economy and power. The limit is set by the octane of the fuel, the intake air temperature, and the load on the engine. A lower than normal amount of advance for similar temperature and speed could indicate too low an octane of fuel is being used.
LOD	Engine Loading	This is a percentage of the maximum power available currently being generated. In some vehicles it is the maximum available at the present RPM.
HP	Horsepower	Displays the calculated Horsepower your vehicle is currently making. This value can be adjusted for accuracy through the Advanced Setup parameters (see page 17).
TFT	Transmission Fluid Temperature	Not all vehicles report TFT. In some cases where TFT is not reported, you may be able to implement this gauge through the X-GAUGE programmable gauge system. Check online at www.ScanGauge.com/support for your specific vehicle.

Trip Computers

Trip Computer Overview

The ScanGauge features 4 built-in trip computers. The trip computers automatically store a set of useful information about the trips you have taken in your vehicle and are updated in real time as you drive.

Built-in Trip Computers		
Trip Computer	Display Name	Available Information
Current Trip	CURRENT	Trip MPG
		Trip Fuel Used
Today's Trips	TODAY	Maximum Coolant Temperature
		Distance
		Maximum RPM
Previous Trips	PREVIOUS DAY	Trip Elapsed Time
		Maximum Speed
		Average Speed
		Trip Fuel Cost
Tank Trips*	TANK	Trip MPG
		Trip Fuel Used
		Distance
		Trip Elapsed Time
		Average Speed
		Trip Fuel Cost
	TANK TO EMPTY	Fuel Remaining for the Current Tank
		Distance Remaining Before Tank Is Empty
		Time Remaining Before Tank Is Empty

* For ScanGauge to maintain accurate tank information, you must first calibrate your ScanGauge using the procedure outlined in **Calibrating Your ScanGauge** (page 20) and follow the **Fill-up Procedure** outlined in the **Filling Up Your Tank** section on page 31, for each subsequent refueling.

Accessing the Trip Computers

From the Home Screen, press the lower left function button next to TRIP, then push the function button next to TRIPS to access the trip computers. Pushing the lower left function button allows you to cycle through the available trip computers.

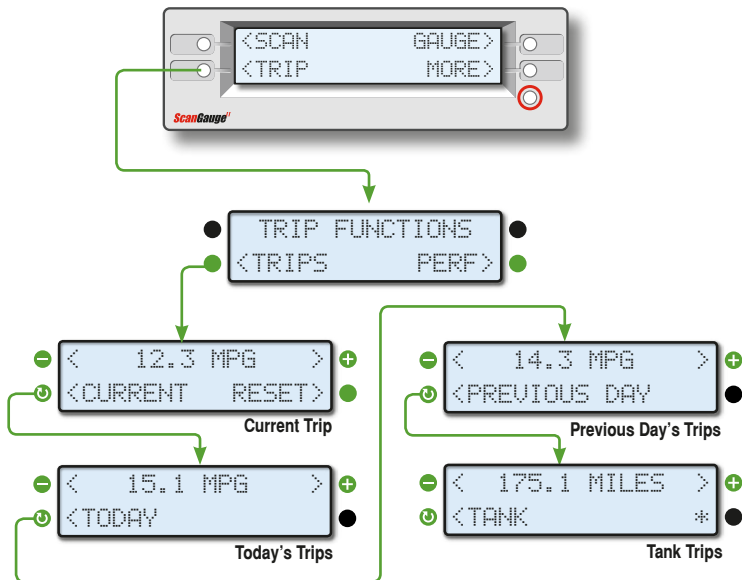

Viewing Available Trip Data

Pressing the upper right or left button will allow you to cycle through available information for the selected trip computer. Selecting the lower right button next to RESET, allows you to reset all trip data.

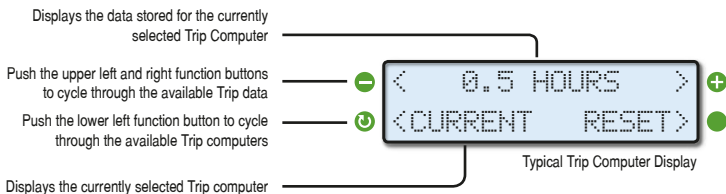

Time-based Trip Computers

The Current Trip (CURRENT), Today's Trip (TODAY) and Previous Day's Trip (PREVIOUS DAY) computers all track similar information for different time periods.

The ScanGauge automatically records trip data as you operate your vehicle. In addition, the information from the Current Trip is automatically transferred to the Today's Trip each time you shut off your vehicle for more than 3 minutes. Information from the Today's Trip is automatically transferred to the Previous Day's Trip when the engine has been shut off for 8 to 10 hours.

To view the trip data, push the upper left or right function buttons to cycle through the available data.

The diagram below uses the **Current Trip** screens as an example.

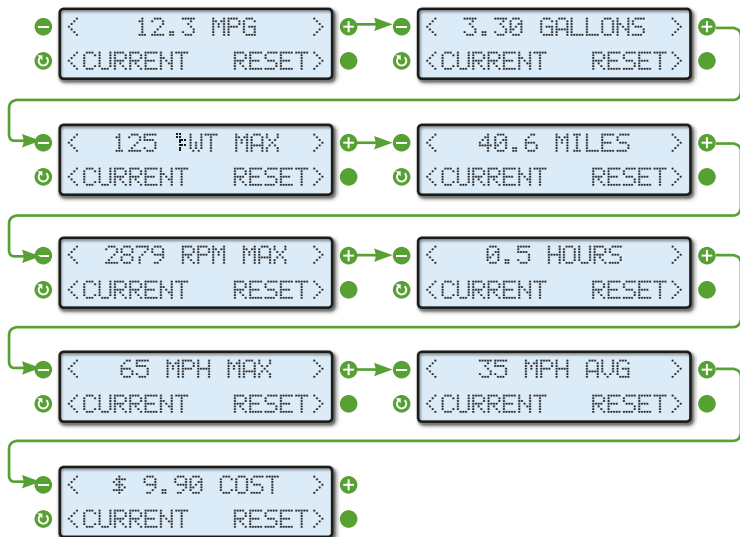

Resetting Current Trip Data

The Current Trip data is automatically reset after about 3 minutes of the ScanGauge being asleep — generally after the vehicle has been shut off. When this happens, the data stored in the Current Trip will automatically be transferred to the Today's Trip.

You can reset the trip data at any time for the Current Trip computers. To reset trip data, simply press the function button next to RESET as shown in the example above.

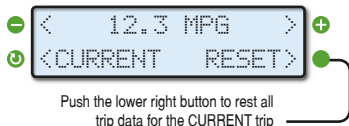

Today's Trip Data

Notice that there is no RESET for TODAY. The Today Trip will automatically reset after the engine has been off for 8 to 10 hours (as when sitting overnight). The values for TODAY will be transferred to the Previous Day's Trip and the values that were in Previous Day's Trip are thrown out.

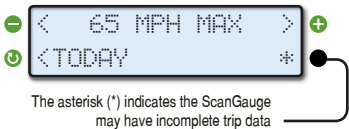

The asterisk (*) in the lower right corner indicates that the ScanGauge was disconnected for at least part of the day and the data may not be complete. This will be transferred to the Previous Day's Trip along with the data.



If the vehicle is driven early in the morning and then not again until late that evening, the data will be transferred to the previous day. If the vehicle is driven until late at night and then used again very early in the morning, the data will stay in the Today's Trip. The end of the Today's Trip requires the vehicle be off, the ScanGauge connected, and the vehicle not driven for 8 to 10 hours.

Fuel-based Trip Computers

The Tank Trip (TANK) and To Empty (TANK TO EMPTY) trip computers can tell you much about the current tank of fuel. For instance, you can learn how much fuel you have used and how far you have traveled since your last fill-up, or how much fuel you have left and the approximate distance you can travel before needing to fill up.



For ScanGauge to maintain accurate Tank Trip information, you must first calibrate your ScanGauge using the procedure outlined in **Calibrating Your ScanGauge** (page 20) and follow the **Fill-up Procedure** outlined in the **Filling Up Your Tank** section on page 31, for each subsequent refueling.

Tank and Tank to Empty Trip Computers

The Tank Trip shows different types of information in some cases from the other trips. The Tank Trip substitutes TANK TO EMPTY data in place of MAXIMUM data.

For instance, the Tank Trip can show you MPG as well as the distance and the amount of time you have traveled on the current tank of fuel. In contrast, the TANK TO EMPTY trip data will show you the amount of remaining fuel in your tank and the approximate distance and time you can travel before needing to refuel.

The Tank Trip information is reset each time you fill up your tank, and follow the **Fill-up Procedure** shown on page 33.

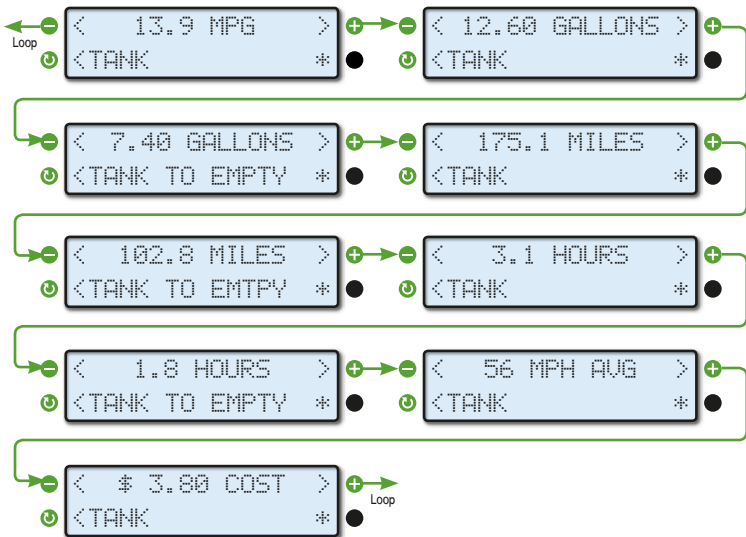

The displays above tell you that if your mileage remains the same as it has since the last fill-up, you have approximately 7.4 gallons of fuel remaining, and that you will run out of fuel in 102.8 miles in about 1.8 hours.

The estimate of distance and time to empty is based on the economy that has been obtained so far on the current tank of fuel. Right after refueling, these values will change fairly quickly. As more of the fuel has been burned from the tank, the readings will stabilize.

It is possible to see the distance and time to empty increase as you drive. The distance can increase as you drive at a steady fuel-efficient speed. This causes the fuel economy for the tank to rise; and applying

this higher fuel efficiency to the fuel remaining in the tank can actually result in more remaining distance. If you drive slower than the average speed of the tank so far, the time to empty can increase.

To maintain accurate **To Empty** information, you must use the following **FILLUP** procedure shown under **Filling Up Your Tank** to indicate the vehicle tank has been refilled. It is also necessary to fill the tank to make the TO EMPTY information correct.

Filling Up Your Tank

To maintain accurate information in the **Tank Trip** and **To Empty** computers, you must tell your ScanGauge that you have filled the tank each time you fuel up your vehicle. To maintain accurate **To Empty** information, it is also important to fill that take to capacity each time you put fuel in the vehicle.



Once you have completed your second fill-up (page 21), subsequent fill-ups may not require adjusting the gallons/liters before pressing DONE.

You should refill the vehicle when there is above 50 miles/km remaining. Pushing below 50 could result in running out of fuel.

When filling your tank, let the pump shut off automatically. Do not top off.

To maintain accurate **TO EMPTY** information in the ScanGauge's trip computers, you should always fill your tank to capacity.

The Fill-up Procedure

To access the Fillup Screen, follow the diagram to the right.

From the Home Screen, press the lower right function button next to MORE. Next, press the upper right function button next to FILLUP.

If the tank is not full, the **To Empty** information will not be accurate and you must be sure not to make an adjustment before pressing DONE the next time you fill-up.

The ScanGauge allows you to change the adjustment factor directly if less than 1 gallon/liter has been used since the previous fill-up sequence was done.

It is not necessary to make an adjustment each time you refuel.

You can press HOME>MORE>FILLUP>DONE when you refuel. This will restart the TANK TO EMPTY Trip computer without changing the adjustment factor.

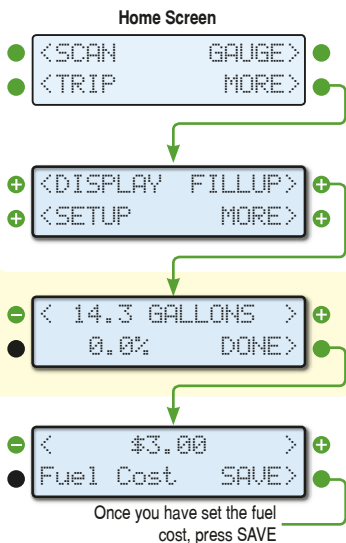

There will be variations in the agreement of the pump fuel used and the ScanGauge indicated fuel use from tank to tank due to:

- Different shutoff levels of the fuel pumps
- Different tilt of the vehicle at the fuel pump due to ground slope or vehicle loading
- Different temperature of the fuel (changes density – best to refill in the morning when the fuel is colder)
- Variations in vehicle sensors due to temperature and time
- Pump accuracy limits

These are just some of the variables that limit absolute accuracy and show why you should never trust a low reading of DISTANCE in the Tank to Empty Trip to believe you will be able to make it to the next gas station.

Scan Tool

Scan Tool Overview

The ScanGauge features a built-in Scan Tool that you can use to view and clear Diagnostic Trouble Codes (DTCs), view the parameters that were present when a Trouble Code was logged, and turn off the Check Engine light.

Access the Scan Tool

From the Home Screen, press the function button next to SCAN to access the built-in Scan Tool. When you press SCAN, the ScanGauge immediately checks your vehicle's computer for any DTCs. Generally, a Trouble Code will cause your Check Engine light turn on.

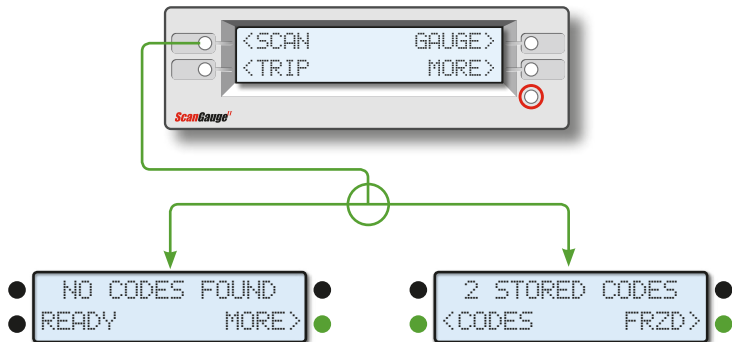

No Codes Found

If no codes were found and your Check Engine light is still on, your vehicle may be storing pending codes. See page 35 for more information about Pending Trouble Codes

Trouble Codes Found

If ScanGauge detects Trouble Codes, the top line will indicate the number of codes found. See page 34 for more information about what to do when Trouble Codes are found.

What to Do if DTCs Are Found

If your vehicle's Check Engine light is on, that's a good indication that your vehicle may be storing Trouble Codes (DTCs). If ScanGauge indicated it has found stored DTCs, you can access the specific code numbers and related Parameter Identification Descriptors (PIDs), also known as Freeze Data, if data was captured when the trouble occurred.



If there are any stored DTCs, ScanGauge will display the number of stored DTCs. Use the lower left function button next to CODES to see the DTCs. Use the lower right function button next to FRZD, to view PIDs.

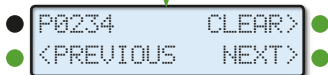

Viewing DTCs

To view the specific DTCs, press the function button next to CODES. If more than one code is stored, you can use the lower left and right function buttons to step through the stored codes.



Viewing PIDs

To step through and view the available PID data, press the lower left and right function buttons.

Gauge values will be shown in the top line for those PIDs that directly correspond to a gauge (see pages 24 and 25 for Gauge Abbreviations).

The values in the second line are in hexadecimal just as they are reported by the vehicle computer. You can exit this mode using the HOME button.

If No Codes Are Found

If no codes are found, ScanGauge will display NO CODES FOUND on the first line. The left side of the second line will display either READY or NOT READY.

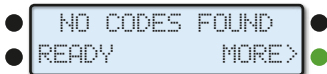

READY - Indicates all tests have been completed since the last reset. This is needed in some states to indicate a valid OBD test for emission testing.

NOT READY - Indicates the vehicle hasn't completed some test cycles. It could take up to several days after codes are cleared for the vehicle to be READY, and your vehicle may not pass some types of emissions testing.

Pending Trouble Codes and Force Clear

If no codes are found, you may still have Pending Trouble Codes. Pending Trouble Codes are DTCs that your vehicle's computer has detected but may not yet have triggered a DTC.

Pending DTCs can be viewed and cleared in much the same way other DTCs can be. After scanning your vehicle and getting a NO CODES FOUND result, press the lower right function button next to MORE. This will scan your vehicle for Pending DTCs.

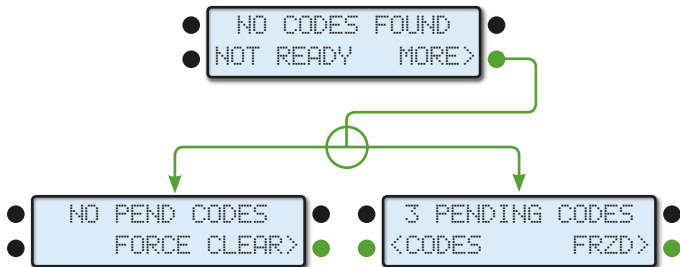

Force Clear

If no Pending DTCs are detected, ScanGauge provides a method to force clear any detected or undetected Trouble Codes. From the NO PEND CODES screen shown above, press the lower right function button next to FORCE CLEAR. ScanGauge will then attempt to force a clear of any pending or existing DTC and turn off the Check Engine light.

Pending Codes

If Pending DTCs are detected, ScanGauge will display the number of pending codes. From the PENDING CODES screen shown above, you can press the lower left function button next to CODES to view the pending DTC. You may also press the lower right function button next to FRZD to view the available Freeze Data and view the conditions in the vehicle that were present when the Pending DTCs were stored.

Decoding DTCs

DTCs vary from vehicle to vehicle, and you will need to find the definitions for your vehicle.

An excellent way to do this is to use a good search engine on the Internet. Use Trouble Codes as the search words. You can add your make of vehicle to narrow the search. Using the actual DTC in the search could bring up a lot of information on the problem if it is a common failure.

A good Web site to try is: <http://www.troublecodes.net>.

Another way to find the Trouble Code meaning and also information on what might be causing the

problem is to do a search on the Trouble Code and the type of vehicle. For instance, searching for "P0401 Ford" will return not only the code definition but also information on the cause and cure.

When you find a list of codes for your vehicle, it would be a good idea to print them out and keep them in the glove compartment for future reference. It is comforting when you are on a trip and the Check Engine light comes on to be able to read the code and determine if it is a critical problem or not.

The shop manuals for your vehicle will also contain information for Trouble Codes.

Clearing Trouble Codes

While viewing the DTC codes, pressing the upper right function button next to CLEAR will result in a prompt from ScanGauge to verify that you want to clear the Trouble Code(s) and turn off the Check Engine light.

If you want to continue and clear the Trouble Codes, press YES. If you decide you do not want to clear the Trouble Codes, press NO.

When the YES button is pressed, ScanGauge will send out a signal to clear all of the Trouble Codes.

While ScanGauge is waiting for a response from the vehicle, the screen will display the message WAITING.

If the process is successful, the display will show CODES CLEARED. This should also turn off the Check Engine light on the dashboard and clear the Freeze Data.

If the display shows NO RESPONSE, the clear codes command was unsuccessful and your vehicle is not responding to the clear command.

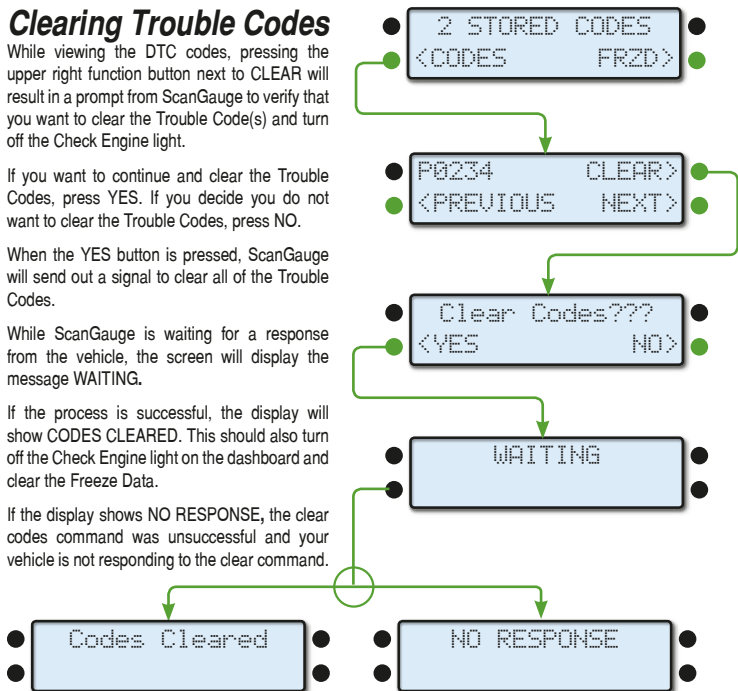

Advanced Features

The ScanGaugell includes a number of advanced features and functions, such as the exclusive X-GAUGE™ programmable gauge system, the built-in vehicle Performance Monitor™ and the ability to send your vehicle's ECU Custom Commands.

The logo for X-GAUGE features the text "X-GAUGE" in a bold, italicized, sans-serif font. The letters are white with a thick yellow outline and a red shadow effect, giving it a three-dimensional appearance.The logo for Performance MONITOR features the word "Performance" in a red, italicized, sans-serif font with a white outline, and the word "MONITOR" in a smaller, black, all-caps, sans-serif font below it.

Program Custom Gauges with X-GAUGE™

X-GAUGE Overview	38
Add or Edit an X-GAUGE	39
Display a Trip Value as an X-GAUGE	42
Using an X-GAUGE	43

Performance Monitor

Performance Monitor Overview	44
Recording a Performance Run	45
Accessing Performance Monitor Data	46
Reading Performance Monitor Data	47
Set a Gauge for Performance Monitoring	48
Save a Performance Run	49
Helpful Tips	49

Custom Commands

Custom Commands Overview	50
Enter and Save a Command	51
Send a Command and Get a Response	51

Overview

While all OBDII compliant vehicles supply a "standard" set of data that ScanGauge can read, some makes and models of vehicles can supply additional information beyond the standard set of data.

Your ScanGauge features the exclusive X-GAUGE™ Programmable Gauge System that provides you a method to tap into this additional information. The X-GAUGE feature allows you to extend the capabilities of your ScanGauge to include things like: vehicle specific gauges, trip data as gauges, and special function gauges.

Programming a new X-GAUGE and saving it to your ScanGauge is simple and easy. Each X-GAUGE consists of specific alpha-numeric strings, or "codes," you enter into the ScanGauge via the front panel push buttons. Your ScanGauge provides enough internal memory to save up to 25 X-GAUGES.

An extensive library of X-GAUGE codes for many different vehicles can be found on our Web site at www.scangauge.com/support

X-GAUGE™

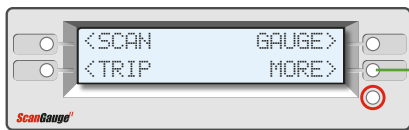

Accessing X-GAUGE Features

From the Home Screen, press the lower right function button twice, next to MORE.

Next, use the upper left and right function buttons to cycle through the available options until the screen titled X-GAUGE appears.

Finally, press the lower right function button next to EDIT to enter X-GAUGE.

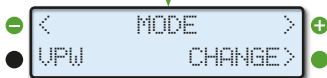
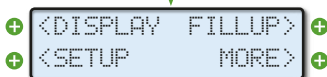

The X-GAUGE Home Screen

From the X-GAUGE Screen, pressing the upper left and upper right buttons allows you to cycle through the 25 available memory slots (0-24). Each memory slot can store an individual X-GAUGE.

If the memory slot is in use, the 3-letter name for the gauge will be shown in the top line next to the memory number. If no name is shown, this memory slot is not being used.

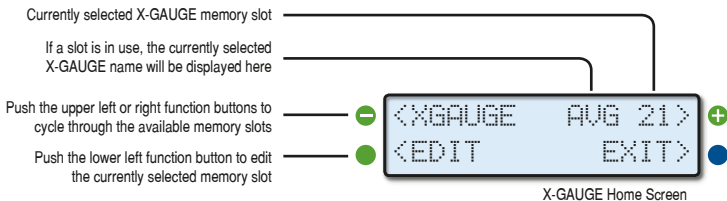

Add or Edit an X-GAUGE

To add a custom X-GAUGE to your ScanGauge, you will need to program the gauge parameters into the ScanGauge using the X-GAUGE Program Parameters Screens. In order to read the data from the vehicle and set up a functional X-GAUGE, you need to have the following information:

- Command to send
- How to identify a response to the command
- Where to find the data in the response
- How to scale, offset and display the data.

The X-GAUGE Program Parameter Screen

An X-GAUGE is entered into the ScanGauge through a series of X-GAUGE Program Parameters. Each X-GAUGE consists of 4 program parameter screens — TXD, RXF, RXD and MTH — as well as one gauge name screen.

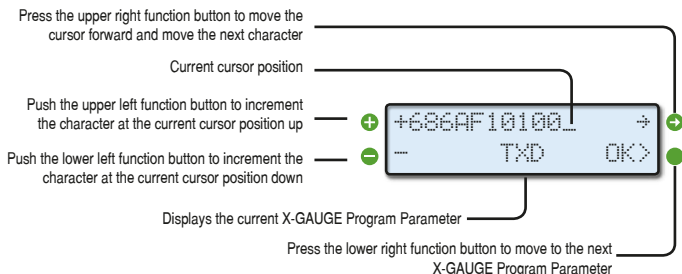

Programming Your Own X-GAUGE

Step 1 - Select an Empty Memory Slot

Start by selecting an empty memory slot by using the upper left and right buttons. Next, press the EDIT button.

Step 2 - Enter the TXD Data

The TXD on the lower line means that the value being entered is the command that will be transmitted to the vehicle's computer.



IMPORTANT: Entries must be an even number of characters. If an odd number of characters is entered, a 0 will be appended to the string to make it even.

A nonspace entry must be made in the first character location, or the X-GAUGE will not be an active gauge.

If the TXD value is blank, no name will be shown; and this X-GAUGE memory will not appear as a selectable gauge.

Step 3 - Enter the RXF Data

The RXF Screen is the entry for the receive filter. This value tells the ScanGauge what to look for in a response from the vehicle's computer.

Also, some of the entries tell the ScanGauge how to display the data. Choices are integer, tenths, hundreds, hexadecimal or on/off. There are also some fields that can turn any trip value into a gauge. When you're done, press the OK button to proceed to the next step.

Step 4 - Enter the RXD Data

The RXD Screen is the entry that tells the ScanGauge where the data and its size are in the response. Entry in this screen is done the same as the other X-GAUGE entry screens. When you're done, press the OK button to proceed to the next step.

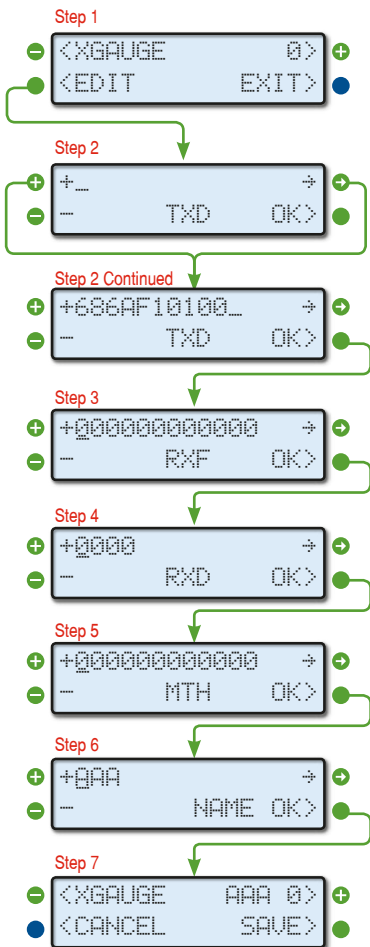

Step 5 - Enter the MTH Data

The MTH (math) screen tells the ScanGauge the math needed to scale and/or offset the value received for the X-GAUGE entry screens. When you're done, press the OK button to proceed to the next step.

Step 6 - Give Your Gauge a Name

The Name Screen allows you to input a 3-letter designator for the name of the gauge you are making. This screen allows a complete ASCII set of characters to be used. This includes punctuation and symbols. You can give the gauge any 3-character name. Please note, you can give your new gauge a name that matches those that are already defined. This should be avoided as it can cause confusion.

When you're done, press the OK button to proceed to the next step.

Step 7 - Saving Your X-GAUGE

To save your new X-GAUGE programming, press the lower right function button next to SAVE. If you wish to discard the changes you have made, press CANCEL. This will cause all the modifications to the X-GAUGE memory slot to be canceled and not saved.



Pressing SAVE will return you to the X-GAUGE Home Screen. The new X-GAUGE name will also appear in the top line, next to the memory slot number.

Copying an X-GAUGE

To a Different Memory Slot

If you want to program a new X-GAUGE that is very similar to one you have already entered, you can copy the program parameter data in one X-GAUGE memory slot to another.

Step 1 - Select an X-GAUGE to Copy

Start by selecting the X-GAUGE you would like to copy. Use the upper left and right function buttons to cycle through the X-GAUGE memory slots until you locate the X-GAUGE you want to copy. Next press the lower left function button next to EDIT.

Steps 2-6 - Edit The Program Parameters

Step through the settings and edit the selected X-GAUGE's program parameters as needed for the new X-GAUGE.

Step 7 - Change Memory Slot and Save

Before pressing SAVE, use the upper left and right function buttons to select a new memory slot.

If an asterisk (*) is present in the top line next to the new X-GAUGE name, then there is already an

Step 1 (select an X-GAUGE)

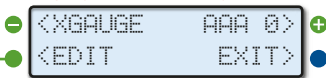

Step 7

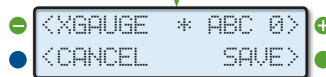

Step 7 (continued)



Saving an X-GAUGE in a particular memory slot will overwrite any X-GAUGE data that may already be saved in that memory slot.

X-GAUGE saved in that memory slot. Saving the new X-GAUGE in that particular slot will overwrite any X-GAUGE data already present in that memory slot. Once you have the desired memory slot selected, press lower right function button next to SAVE. All the data will be written to that X-GAUGE memory slot, leaving the previously selected memory slot unchanged.

Disabling an X-GAUGE

To disable an X-GAUGE already in memory, start as if you were going to edit the gauge. In the TXD Screen, change the first character to a space. Continue to step through the editing fields by pressing the lower right function button next to OK and press SAVE to exit the screen. This will actually delete the data to transmit, which tells the ScanGauge not to use this X-GAUGE. The name will not be displayed. If you put transmit data back into this gauge, it will be reactivated.

Displaying a Trip Value as an X-GAUGE

You can set any of the built-in trip values and have them displayed as a gauge. This allows you to monitor trip functions along with other gauge functions.

In the example to the right, a custom X-GAUGE that displays the Time Driven Today is set up.

Step 1

To get started, choose an empty memory slot from the X-GAUGE Screen. Then press the lower left function buttons next to EDIT.

Step 2

In the TXD Screen, the first character determines which trip function will be displayed. Choose a number from the **Available Trip Parameters** chart on the next page.

The second character determines which trip to use. Choose a number from the **Trip Designations** chart on the next page.

When you're done, press the lower right function button next to OK to move to the next screen.

Step 3

For RXF, make the first character an 8 as shown to the right.

An 8 as the first character is a special condition that tells the ScanGauge that this is to be a trip gauge. All values after the 8 are ignored.

When you're done, press the lower right function button next to OK to move to the next screen.

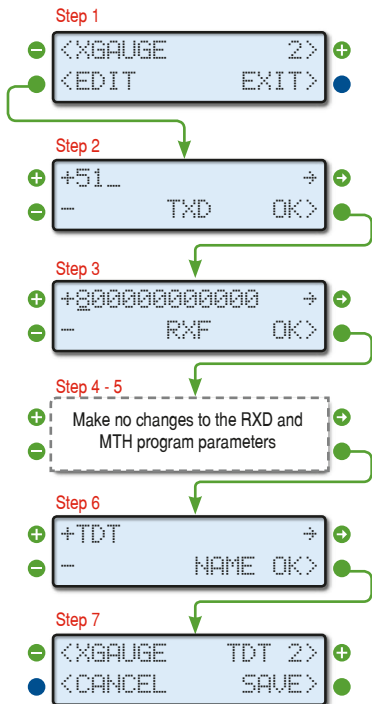

Steps 4 and 5

Do not make any changes to the RXD and MTH screens. Simply press the lower right function button next to OK until you reach the name screen.

Available Trip Parameters	
Parameter	Trip Name
0	Average Fuel Economy
1	Fuel used
2	Max Coolant Temperature or Fuel Remaining for TANK trip
3	Distance
4	Max RPM or Distance to Empty for TANK trip
5	Time
6	Max Speed or Time to Empty for TANK trip
7	Average Speed
8	Cost

Step 6

Enter a name for your new X-GAUGE. For this example, we used TDT for Time Driven Today. When you're done, press the lower right function button next to OK, to move to the next screen.

Step 7

To complete this X-GAUGE, press lower right function button next to SAVE. Once saved, the new X-GAUGE will be available on the GAUGE screen along with other gauges (see page 23).

Trip Designations	
Designation	Trip Name
0	Current Trip
1	Today's Trip
2	Previous Day's Trip
3	Tank Trip

Using an X-GAUGE

After an X-GAUGE has been created, it can be selected like any other gauge. In the Gauge screen (see page 23), press the function button next to the gauge position you want to use for the X-GAUGE. Keep pressing as needed until the X-GAUGE name appears.

For instance, if the following screen were visible, pressing the button next to RPM a number of times would eventually reach TDT.

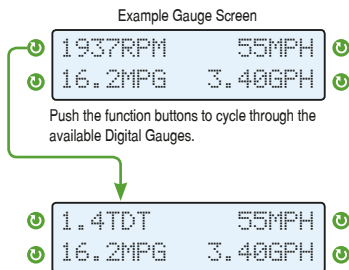

Performance Monitor

Overview

The Performance Monitor™ provides the ability to track the performance of your vehicle over short periods of time, distance and acceleration. You can also designate a specific digital gauge to track, as well as store and recall the recorded data. You can think of the Performance Monitor as a performance-based Trip computer with a specialized purpose.



Accessing the Performance Monitor Features

From the Home Screen, press the lower left function button next to TRIP. Next, press the lower right function button next to PERF. Follow the diagram shown below.

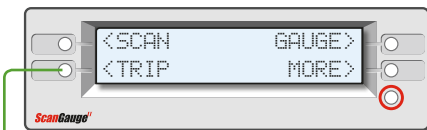

Performance Run Data

The Performance Monitor records key data parameters during the course of the Performance Run. These include the elapsed time, speed, distance traveled and a user-defined digital gauge. See information below to select a built-in digital gauge for monitoring. The chart below outlines the data parameters the Performance Monitor records and a brief description of this parameters.

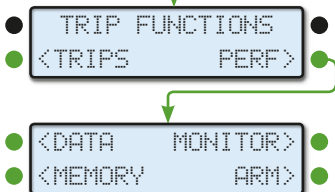

Available Performance Data Parameters

Parameter	Description
Time	The amount of elapsed time at each data point from the beginning of the Performance Run to the end of the run
Speed	The speed of the vehicle at each data point
Distance	The total distance traveled at data point
Monitored Gauge	Use the Monitor Function to select a built-in digital gauge to monitor. Data will be recorded for the selected gauge.

Recording a Performance Run

To record a Performance Run you must first arm your ScanGauge. Arming the ScanGauge is easy—simply press the lower right function button next to ARM.

Arming the ScanGauge

ScanGauge will enter the **Armed** state and begin monitoring your speed. The Performance Monitor uses a MPH trigger to determine when to begin recording.

The ScanGauge will remain in the Armed state until a change in your speed is detected. Once a change is detected, the Performance Monitor is “triggered,” and recording automatically begins.

The Recording Screen

While recording, ScanGauge will display the Recording Screen. This screen shows your vehicle’s current speed and the elapsed time of the run. It will continue to record data for a period of 24 seconds or until ScanGauge detects a speed of 0 MPH. You can also manually stop the record process anytime by pressing the upper right function button next to STOP.

The Postrun Screen

Once the Performance Run is complete and recording has stopped, ScanGauge will then display the Postrun Screen. This screen allows you to immediately view or save the recorded data, or rearm for a second run.

Performance Monitor Home Screen

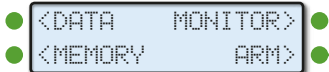

Armed



Recording Screen



Postrun Screen

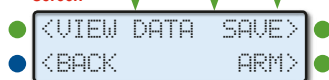

Pressing ARM discards any unsaved data from a previous run.



IMPORTANT: OBSERVE ALL SPEED LIMITS AND DRIVE SAFELY WHILE USING PERFORMANCE MONITOR™.

Accessing the Performance Monitor™ Data

There are multiple ways to access the data screens. You can view the data immediately after a Performance Run from the Postrun screen. You can also access the most recent run currently in temporary memory from the Performance Monitor Home Screen. In addition, you can recall and load a saved Performance Run from the Memory Screen.

Access Data Immediately After a Performance Run

Once a Performance Run is complete, the ScanGauge will display the Postrun Screen. To view the data immediately after a Performance Run, push the upper left function button next to VIEW DATA. The Performance Run data will remain in temporary memory until you save the data or rearm the ScanGauge.



Access Data From the Performance Monitor Home Screen

ScanGauge will store the most recent Performance Run in temporary memory. To access the most recently recorded data from the Performance Monitor Home Screen, press the upper left function button next to DATA.

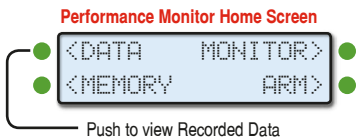

Recall and Load a Saved Performance Run

ScanGauge can store up to 8 Performance Runs. You can access a saved Performance Run through the Memory Screen.

From the Performance Monitor Home Screen, press the lower left function button next to MEMORY. Next, use the upper left and right function buttons to select a memory. An asterisk (*) next to the memory slot number indicates that the selected memory slot contains saved data. Finally, push the lower left function button next to RECALL and load the saved Performance Run data.

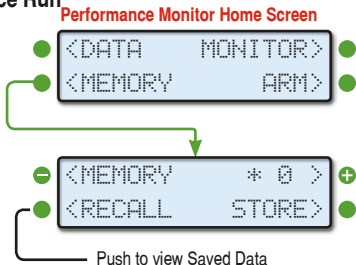

An asterisk (*) next to the memory slot number indicates that the selected memory slot contains saved data.

Reading Performance Monitor™ Data

The data the Performance Monitor records can be read through the DATA screen. The data screen displays the speed, distance and elapsed time for each data point. A data point is generated each time the Performance Monitor records data.

While viewing the Data screen, you can use the upper left and right function buttons to step through the data points.

Displays the MPH/KPH recorded for the current data point

Displays the distance traveled for the current data point

Push the upper left and right function buttons to step through the data

Push to return to the previous screen

Displays the elapsed time recorded for the current data point

Indicates the currently selected step-through parameter (see chart below)

Push the lower right function button to toggle the step-through parameter (see chart below)

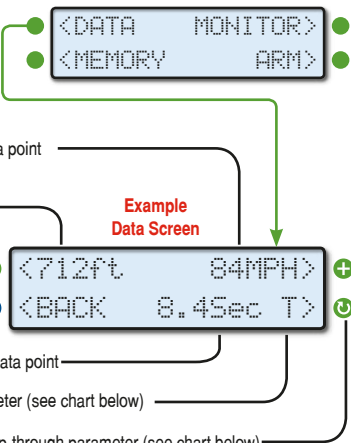

Stepping Through Recorded Data

The lower right function button toggles the step-through mode, allowing you to step through the data points using the different criteria. The currently selected step-through mode is shown next to the lower right function button.

The information layout on the DATA screen maintains a consistent layout as you switch between data step-through modes. For instance, Distance (ft) is shown in the upper left of the screen, while speed (MPH/KPH) is shown in the upper right of the screen, and elapsed time (Sec) is shown near the bottom middle portion of the screen.

See the chart **Step-Through Parameters and Recording Rates** on the following page for more information about each Data parameter and step-through intervals.

Step-thru by Time



Step-thru by Speed

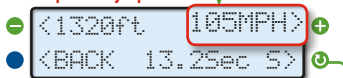

Step-thru by Distance



Monitored Gauge



Step-through Parameters and Recording Rates

Parameters	Display	Step Thru Intervals
Time	T	Data is recorded and can be viewed incrementally every: - 0.2 seconds with MONITOR Turned OFF - 0.4 seconds with MONITOR turned ON
Speed	S	Data can be viewed incrementally every 5 MPH/KPH
Distance	D	Data can be viewed incrementally every 100ft with special data points at: 60ft, 330ft (1/16 mile), 660ft(1/8 mile), 1320ft (1/4 mile), 2640ft (1/2 mile) and 5280ft(1 mile)
Monitored Gauge	M	Data is recorded and can be viewed incrementally every 0.4 seconds Only Available if a monitored gauge was set for the Performance Run

The rate at which data is recorded may vary for each data parameter. Factors that can affect the recording rate include the particular protocol your vehicle uses (see page 57), whether or not you have set the Performance Monitor to monitor a built-in gauge (see below), and even the vehicle itself.

Set a Gauge for Performance Monitoring

In addition to the three key performance data parameters; distance, speed and time, the Performance Monitor also allows you to set an additional data parameter for recording. The MONITOR function allows you to select and “turn on” any one of the built-in digital gauges (see page 24).

To access the MONITOR function and set a digital gauge to be monitored, start by pressing the upper right function button next to MONITOR on the Performance Monitor Home Screen. Next, use the upper left function button to cycle through the available gauges. Once you have the gauge you want to monitor selected, press the upper right function button to toggle MONITOR ON.

When you're ready, you can arm ScanGauge for a Performance Run by pressing the lower right function button next to ARM. With a digital gauge selected, and the Monitor set to ON, the Performance Monitor will now record data for the selected gauge.

Displays the currently selected gauge

Push to cycle through the available gauges

Push to return the previous screen

RPM MONITOR ON
<BACK ARM>

Push to arm ScanGauge for a Performance Run

Performance Monitor Home Screen

<DATA MONITOR>
<MEMORY ARM>

Push to toggle MONITOR ON and OFF

Save A Performance Run

You can save a Performance Run for later review. ScanGauge provides storage slots for up to 8 Performance Runs in the Memory Screen. You can save a Performance Run anytime after it has been recorded - the most recent run will remain in temporary memory until you either rearm the Performance Monitor or until ScanGauge is turned off or unplugged.

The Memory screen is accessible from a few different locations including the Performance Monitor Home Screen, and the Postrun Screen as shown in the diagram below.

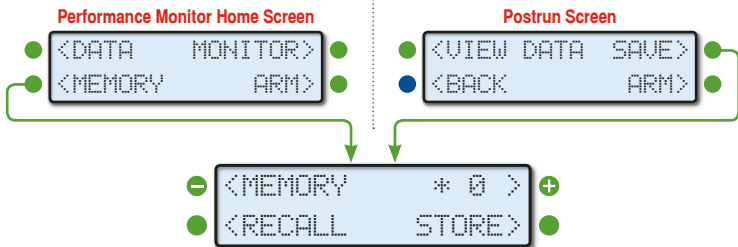

An asterisk (*) next to the memory slot number indicates that the selected memory slot contains saved data.

Helpful Tips

The Performance Monitor can provide a wealth of information about your vehicle's performance. Here are a few quick tips on how to use the data after a Performance Run to help get the most out of the Performance Monitor. For more tips, visit us online at: www.ScanGauge.com/quick-tips.

Get Your 1/4-mile time

On the Data Screen, set the step-through parameter to Distance (D) and step through the data until distance shows 1320ft.

Get Your 0-60 MPH time

On the Data Screen, set the step-through parameter to Speed (S) and step thru through data until speed (MPH) shows 60MPH. The time displayed on the bottom line is your 0-60 time.

Get Braking Performance — 60-0 MPH and Braking Distance

On a closed course, start by bringing your vehicle up to speed, **just below 60 MPH**, and hold your speed while your passenger arms the Performance Monitor. Then, bring your vehicle's speed up to 60 MPH and then begin braking. Once your speed reaches 0, the Performance Monitor will automatically stop recording data. Finally, set the step-through parameter to Speed (S) and step through the data until speed shows 0 MPH. Read the distance (ft) parameter for breaking distance and the time (Sec) parameter for breaking time.

Custom Commands Function

Custom Commands Overview

The Custom Commands function allows you to create and save any arbitrary commands and then send those commands to your vehicle's ECU for a response. This advanced function can be especially useful when troubleshooting communication issues between your ScanGauge and your vehicle's ECU as well as for those individuals who are familiar with the OBDII protocols.

Accessing the Commands Feature

From the Home Screen, press the lower right function button twice, next to MORE. Next, use the upper left and right function buttons to cycle through the available options until the screen titled COMMANDS appears. Finally, press the lower right function button next to EDIT to enter Commands Menu.

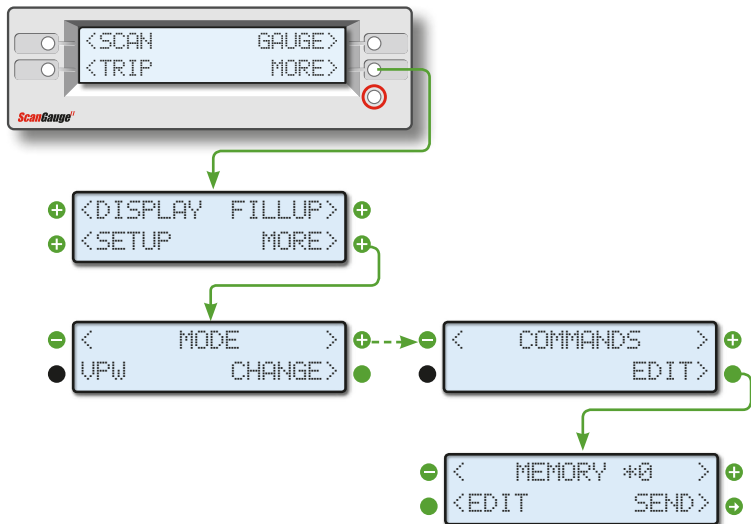

The Commands Home Screen

From the Commands Home Screen, pushing the upper left and upper right buttons allows you to cycle through available memory slots. Each memory slot can store an individual command.

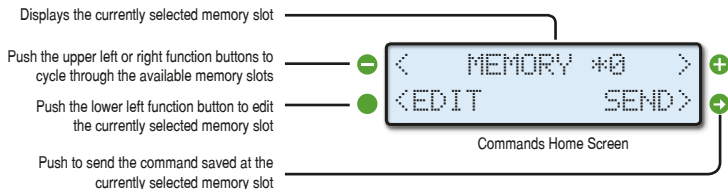

Enter and Save a Command

To enter a command into your ScanGauge, you will need to enter a hexadecimal string. The command can be made up of numbers (0 to 9), characters (A to F) and spaces. ScanGauge will allow you to enter the maximum number of characters the currently selected protocol or MODE allows for (see page 57).

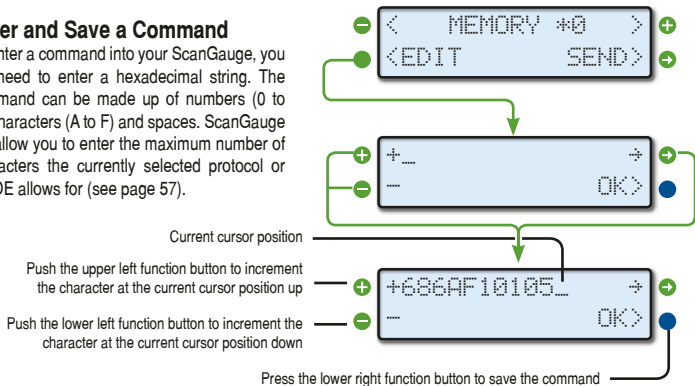

Send Command and Get a Response

Pressing SEND causes the command to be sent to the vehicle's ECU. If there is a response to the message, it will be shown.

The first response returned after the command is sent is displayed. If there is a lot of traffic on the bus, this may not be the response to the command you sent. It may be necessary to resend the command and check for the correct response.

Pressing the lower right function button next to OK will return you to the Command Home Screen.

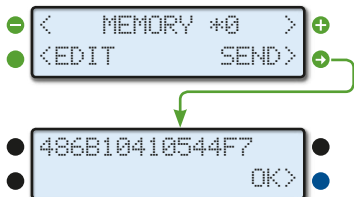

Troubleshooting

This section provides basic troubleshooting information. For more comprehensive information, please visit us online at: www.ScanGauge.com/support.

Basic Troubleshooting	53
View Firmware Version	55
Reset Your ScanGauge	56
Read or Set the Operating Mode	57

Basic Troubleshooting

Where to Get Support

Below is a list of the more common troubleshooting tips. For a more comprehensive list of troubleshooting tips, tricks and frequently asked questions, please visit us online.

Online: www.ScanGauge.com/support
www.facebook.com/ScanGauge

Toll Free: 1-888-433-5664

E-mail: support@linear-logic.com

Problem	Possible Cause	Solutions
Nothing displayed and no backlight	Vehicle has a blown fuse	Replace blown vehicle fuse. The OBDII connector is usually powered off the cigarette lighter/accessory fuse. Check this one first.
Never stops saying "Connecting..."	Vehicle ECU not on	Turn key to RUN or start engine
	ECU not responding properly	Use MORE>MORE>MODE and try Forcing the following modes: FORD Products: PWM or CANSF GM Products: VPW , ISO or CANSF Chrysler Products: ISO, VPW or CANSF Volvo Products: ISO, CANSF or CANLF Others: ISO, KWPS, KWPF, CANSF, CANLF, CANSS or CANLS
	Vehicle is not OBDII, OBD2 or EOBD compatible	None — ScanGauge requires vehicle to be OBDII, OBD2 or EOBD compatible.
Connects and then goes to sleep after 10 to 15 seconds	Engine is not running	Start engine.
	ECU requires only supported PIDs (common on 1995-1999 Subaru)	Set the PIDs method to SUPPORTED in the Advanced Setup Options (see page 18).

Problem	Possible Cause	Solutions
Unable to clear trouble codes	Vehicle is not responding to the Clear Codes command	Sometimes multiple attempts are needed to clear the codes. You may also try clearing the codes with the vehicle not running, and the key in the on position. Some vehicles don't respond properly to the Clear Codes command and the codes cannot be cleared by the ScanGauge.
Shuts off when engine automatically turns off in a Hybrid vehicle	Fuel type not set to HYBRID	Set the fuel type (TYPE) parameter to HYBRID in the Basic Setup Parameters (see page 12), ScanGauge will automatically set the Sleep Event parameter to NO COMM.
Poor MPG and Trip Fuel use accuracy	Some sensor initial accuracy not good (especially Diesel)	Use FILLUP procedure to adjust for sensor errors. (see page 31).
When I scan the vehicle, it displays NOT READY	The vehicle has not completed its readiness Tests since the last time it was cleared or the battery was disconnected.	It will continue to say "NOT READY" until all on board diagnostic tests have been completed. This does not mean that it is not ready to be scanned. To get to this screen the vehicle computer reported that no Trouble Codes exist. Some states require that some or all on-board tests be completed and no Trouble Codes be present to pass emissions testing. When the ScanGauge reports No Codes Found and READY, the vehicle is ready to pass emissions. Some states allow some tests to not be completed and can pass the vehicle even when the ScanGauge reports NOT READY.
Trip Fuel use is very inaccurate after using fill-up adjustment	Error in adjustment procedure	Recalibrate your ScanGauge. See CalibratingYour ScanGauge on pages 20 and 21

Problem	Possible Cause	Solutions
Some gauges are blank	Some sensors are not used in the vehicle or data is not reported by ECU	About 10% of vehicles show FPR and 50% show MAP. 1995-1999 Subaru don't show intake air temperature. Some Ford diesels don't show coolant temperature. For a compressive compatibility list, please visit: www.ScanGauge.com/support

View Firmware Version of Your ScanGauge

From the Home Screen, push the lower right function button twice next to MORE. Next, use the upper left and right function buttons to cycle through the available options until you reach the screen titled Version.

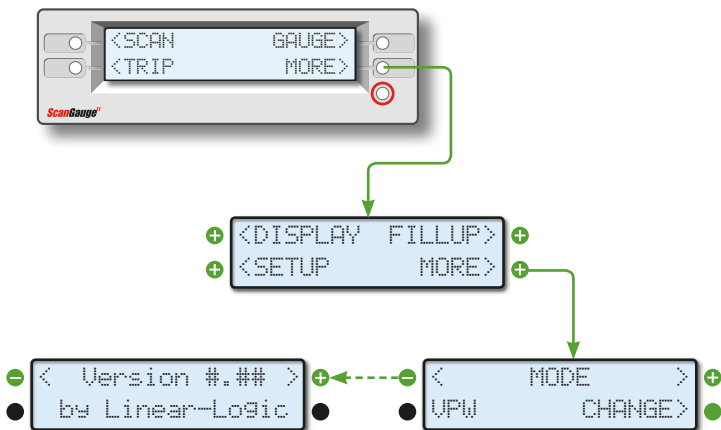

Reset Your ScanGauge

You can reset your ScanGauge to factory defaults and clear all custom settings and saved data.

To Reset Your ScanGauge

From the Home Screen, push the lower right function button twice next to MORE. Next, use the upper left and right function buttons to cycle through the available options until you reach the screen titled; Use Defaults??.

To begin the process, push the lower left function button next to YES.

The next screen will ask you to confirm the reset. To complete the process, push the lower right function button next to YES.

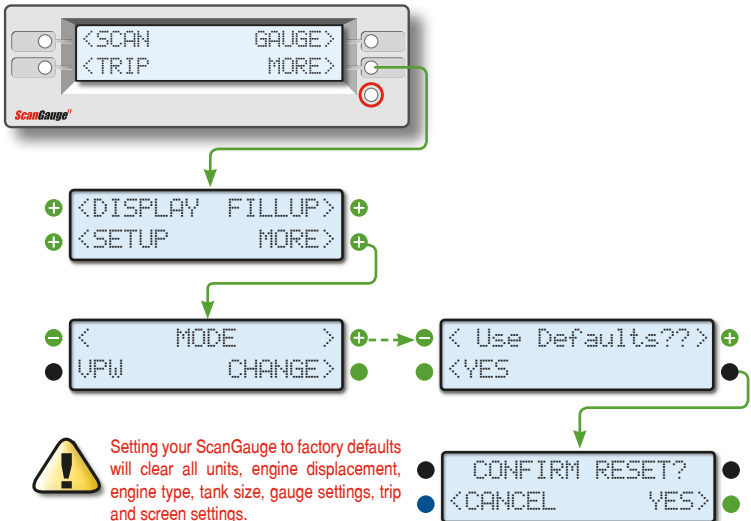

Read or Set the Operating Mode

ScanGauge allows you to view the operating mode your ScanGauge is using to communicate with your vehicle's ECU. You may also manually set the mode.

From the Home Screen, push the lower right function button twice next to MORE. Next, use the upper left and right function buttons to cycle through the available options until you reach the screen titled MODE. The current mode will be displayed in the lower left corner of the screen.

To manually set ScanGauge to use a particular mode, push the function button next to CHANGE, to enter the MODE screen.

Next, use the upper left and right function buttons to cycle through and select a particular mode. Finally, press the lower right function button next to FORCE to set ScanGauge to use the selected mode when communicating with your vehicle's ECU.

The mode should be set this way only if it cannot be determined automatically.

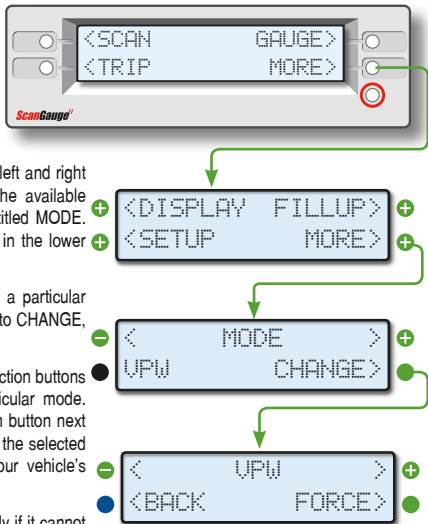

Notes:

Limited Warranty

Linear Logic will repair this product with new or rebuilt parts, free of charge, for a period of 3 years from the date of original purchase in the event of a defect in materials or workmanship.

Warranty Service can be obtained by sending the product to:

Linear Logic LLC
ATTN: Warranty Service
2222 S Dobson Rd Suite 800
Mesa, AZ 85202

Include your name, address, telephone number and/or e-mail address along with a copy of the Receipt or Packing List.

Also include information about the problem, including the type of vehicle you are using it on and a description of the problem.

An e-mail to service@Linear-Logic.com may be able to assist in solving a problem and will not diminish your rights to the full warranty.

Limits and Exclusions:

There are no express warranties except as listed above.

Linear Logic SHALL NOT BE LIABLE FOR INCIDENTAL OR CONSEQUENTIAL DAMAGES RESULTING FROM THE USE OF THIS PRODUCT OR ARISING OUT OF ANY BREACH OF THIS WARRANTY. ALL EXPRESS AND IMPLIED WARRANTIES, INCLUDING THE WARRANTIES OF MERCHANTABILITY AND FITNESS FOR A PARTICULAR PURPOSE, ARE LIMITED TO THE APPLICABLE WARRANTY PERIOD.

If a problem with this product develops after the warranty period, you may contact our service department via the mail address or e-mail address listed above for a cost estimate on repairs to the unit.

If the problem is not handled to your satisfaction, contact our customer care department at customer.care@Linear-Logic.com.

ScanGauge By Linear Logic **II**™

www.ScanGauge.com